

PRINTER

PR4 DR

**USER'S GUIDE
GUIDA OPERATIVA
GUIDE D'UTILISATION
BEDIENUNGSANLEITUNG
GUIA OPERATIVA**

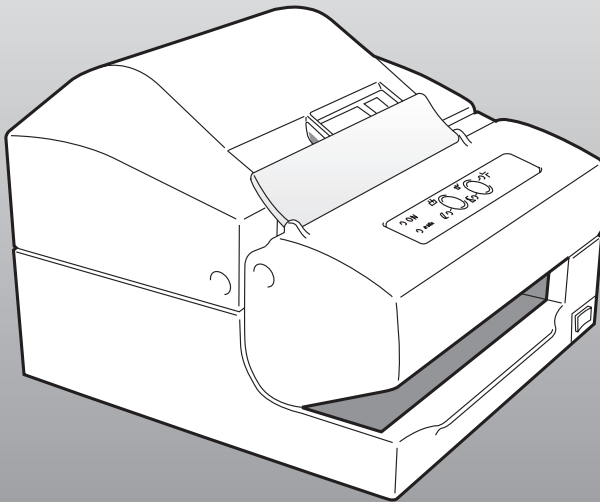

olivetti

Publication issued by:

Publishing department:

Olivetti Lexikon, S.p.A.

P.B.U. Ink-Jet

Documentazione Utente

Via Romano, 1 - 10010 - Scarmagno (Italy)

Copyright ©1999 by Olivetti

All rights reserved

The CE and IMQ marks affixed to the product certify that the product satisfies the basic quality requirements.



Your attention is drawn to the following actions that could compromise the characteristics of the product:

- incorrect electrical supply;
- incorrect installation; incorrect or improper use, or, in any case, not in accordance with the warnings given in the User Guide supplied with the product;
- replacement of original components or accessories with others of a type not approved by the manufacturer, or carried out by unauthorized personnel.



To clean the machine, use a vacuum cleaner or soft cloth.

First remove the mains plug from the wall socket.

Do not use alcohol, solvents, or hard brushes.

Do not let water or other liquids get inside the machine.

Si richiama l'attenzione sulle seguenti azioni che possono compromettere la conformità sopra attestata, oltre, naturalmente, le caratteristiche del prodotto:

- errata alimentazione elettrica;
- errata installazione o uso errato o improprio o comunque difforme dalle avvertenze riportate sul manuale d'uso fornito col prodotto;
- sostituzione di componenti o accessori originali con altri di tipo non approvato dal costruttore, o effettuata da personale non autorizzato.



Per pulire la macchina, utilizzare un aspirapolvere o un panno morbido.

Prima di ogni operazione, scollegare il cavo di alimentazione elettrica dalla presa di rete.

Non utilizzare alcol, solventi o spazzole dure.

Assicurarsi che acqua o altri liquidi non penetrino all'interno della stampante.

Nous attirons l'attention sur certaines opérations qui pourraient compromettre la conformité attestée ci-dessus et les caractéristiques du produit même:

- Alimentation électrique erronée;
- Installation ou utilisation incorrecte, non appropriée ou ne respectant pas les indications reportées dans le manuel d'utilisation fourni avec le produit;
- Remplacement des consommables ou des accessoires originaux par d'autres types non approuvés par le constructeur ou effectué par du personnel non autorisé.



Pour nettoyer la machine, utiliser un aspirateur ou un chiffon souple.

Avant d'effectuer toute opération, débrancher le câble de l'alimentation électrique de la prise de réseau.

Ne pas utiliser de l'alcool, des solvants, ni des brosses dures.

Vous assurer que ni l'eau ni aucun autre liquide ne pénètrent dans l'imprimante.

Wir möchten Sie darauf hinweisen, daß folgende Aktionen die oben bescheinigte Konformität und die Eigenschaften des Produkts beeinträchtigen können:

- Falsche Stromversorgung;
- Installations- oder Bedienungsfehler bzw. Nichtbeachtung der Hinweise in der Bedienungsanleitung, die mit dem Produkt geliefert wurde;
- Das Auswechseln von Bauteilen oder Originalzubehör durch Unbefugte oder das Ersetzen durch Teile, die nicht vom Hersteller anerkannt werden.



Zum Reinigen der Maschine einen Staubsauger oder einen weichen Lappen benutzen.

Zuerst den Hauptstecker aus der Netzsteckdose ziehen.

Keinen Alkohol, Lösungsmittel oder harte Bürsten verwenden.

Darauf achten, dass kein Wasser oder andere Flüssigkeiten in die Maschine eindringen.

Le rogamos que preste mucha atención a las siguientes acciones que pueden comprometer la conformidad arriba certificada, y obviamente las características del producto:

- Alimentación eléctrica errónea;
- Instalación o uso erróneos, impropios o no conformes a las advertencias detalladas en el manual de utilización suministrado con el producto;
- Sustitución de componentes o accesorios originales con otros no aprobados por el fabricante, o bien efectuada por parte de personal no autorizado.



Para limpiar la máquina, utilice una aspiradora o un paño suave.

Antes de cualquier operación, desconecte el cable de alimentación eléctrica de la toma de red.

No utilice alcohol, solventes o cepillos duros.

Asegúrese de que agua u otros líquidos no penetren dentro de la impresora.

Table of contents
Indice
Table des matières
Inhaltsverzeichnis
Indice

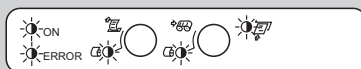
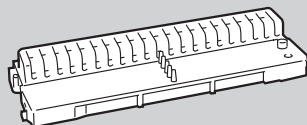
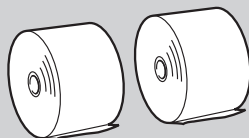
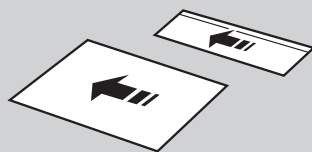
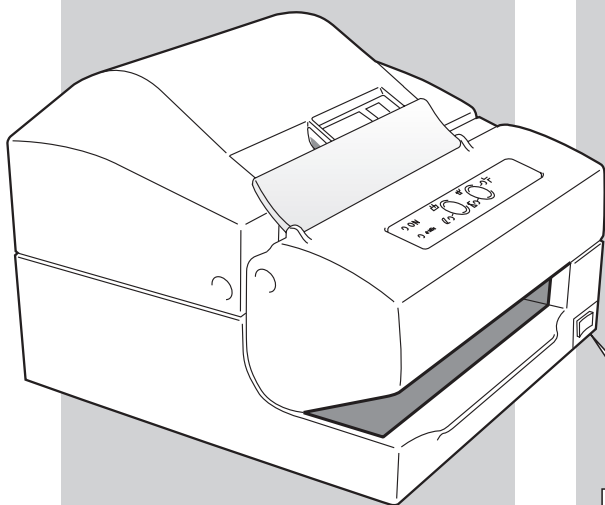

- GB** Main switch, if ordered
- I** Interruttore ove previsto
- F** Interrupteur, s'il est prévu
- D** Hauptschalter, falls bestellt
- E** Interruptor, si previsto

olivetti

● ON

○ ERROR

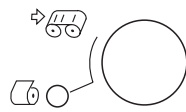
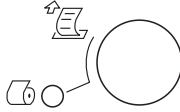

- Loading a document from the top
- Caricamento del documento dall'alto
- Chargement du document par le haut
- Laden des Dokuments von oben
- Introducción superior del documento

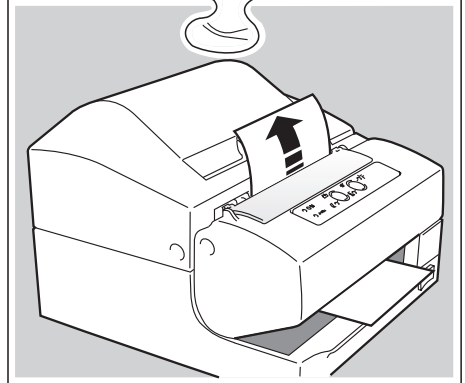
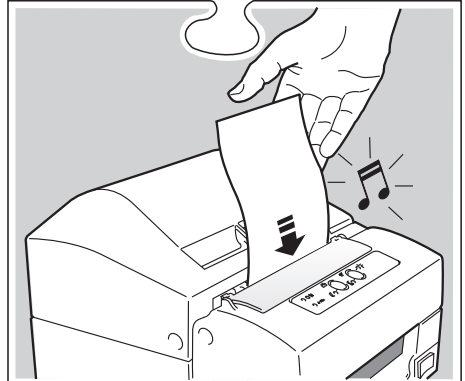
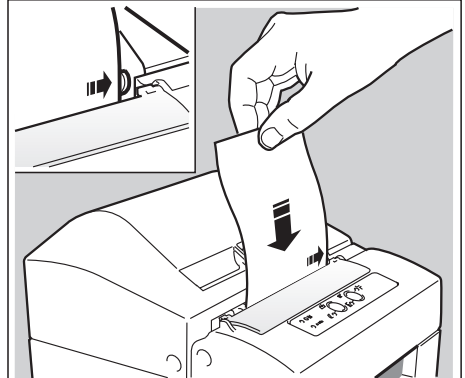
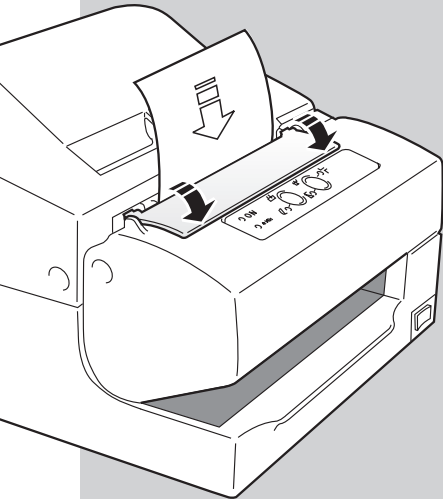

● ON

○ ERROR

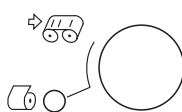
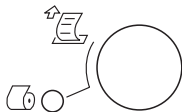

- Front loading of a document
- Caricamento frontale del documento
- Chargement frontal du document
- Laden des Dokuments von vorne
- Introducción frontal del documento

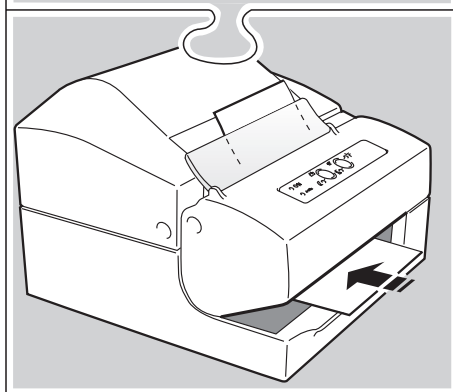
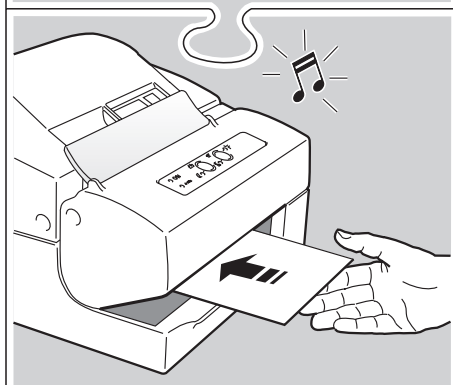
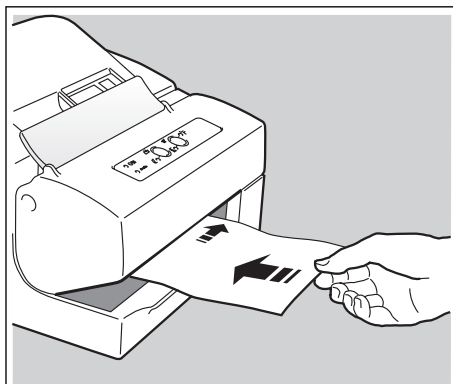
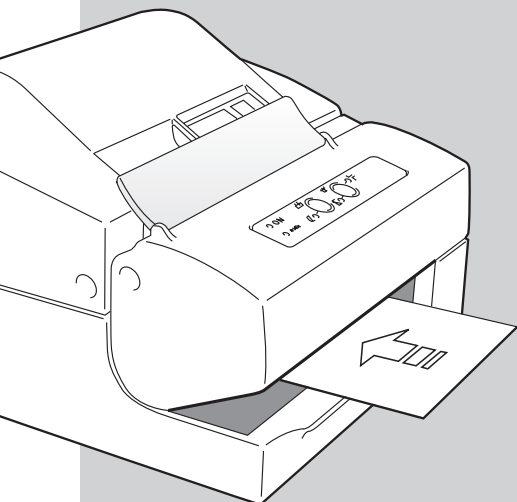

● ON

○ ERROR

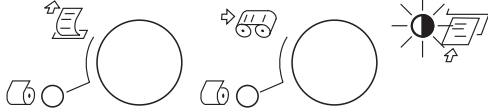

- Reading the cheque code line
- Lettura della code line dell'assegno
- Lecture de la ligne de programmation du chèque
- Lesen der Codierzeile auf dem Scheck
- Lectura de la "code line" del cheque

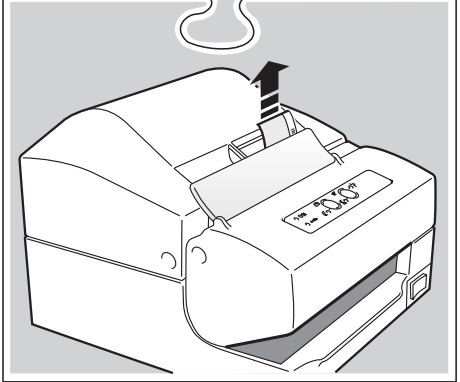
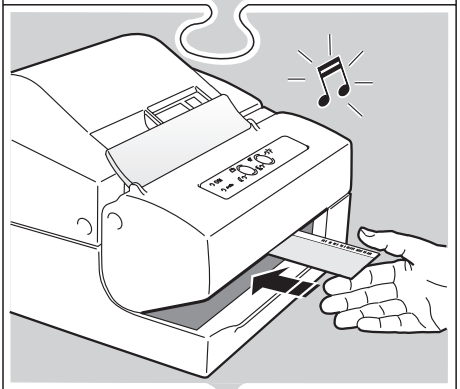
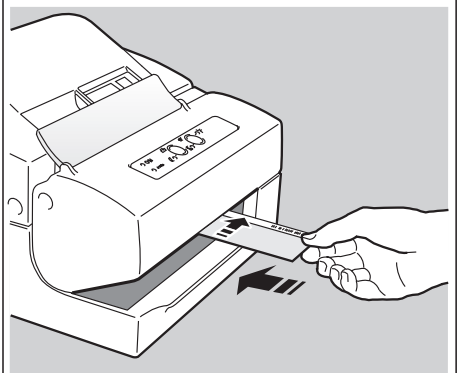
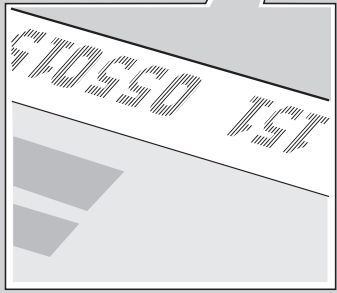
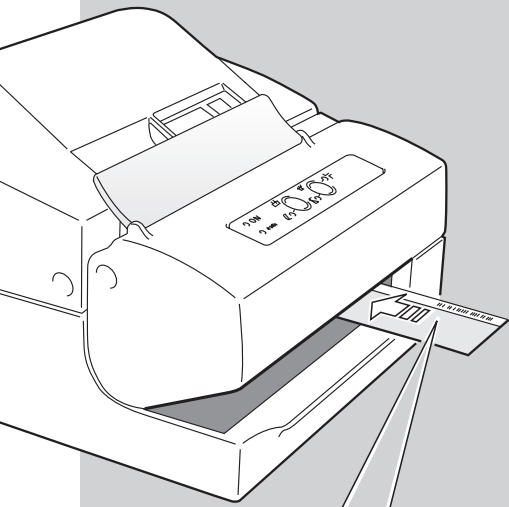

● ON

○ ERROR

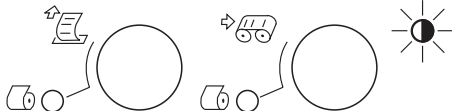

- Front loading of crumpled or damaged documents
- Caricamento frontale di documenti sgualciti o rovinati
- Chargement frontal de documents froissés ou déchirés
- Vorderseitige Zufuhr von zerknitterten oder eingerissenen Dokumenten
- Carga frontal de documentos ajados o estropeados

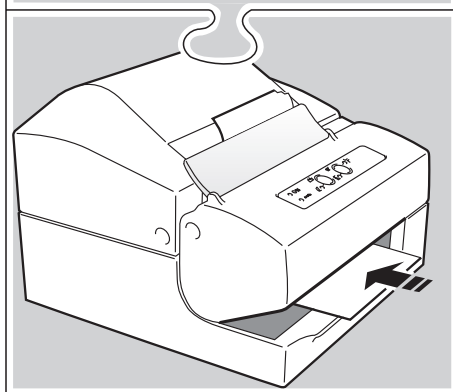
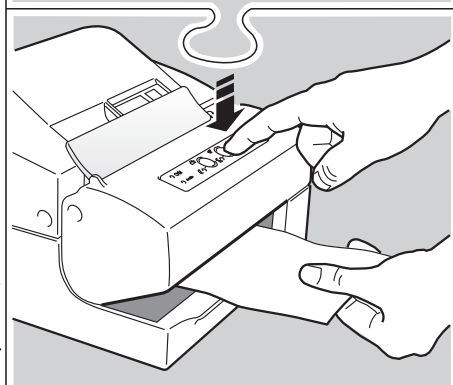
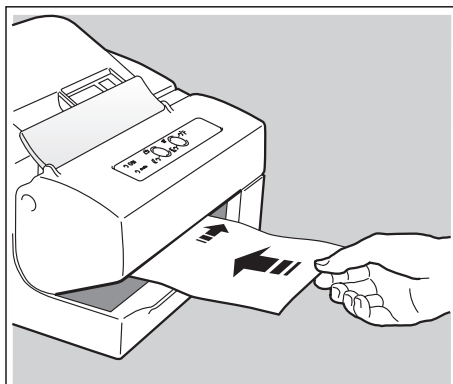
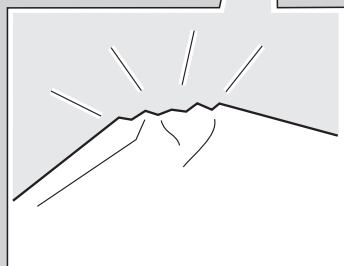
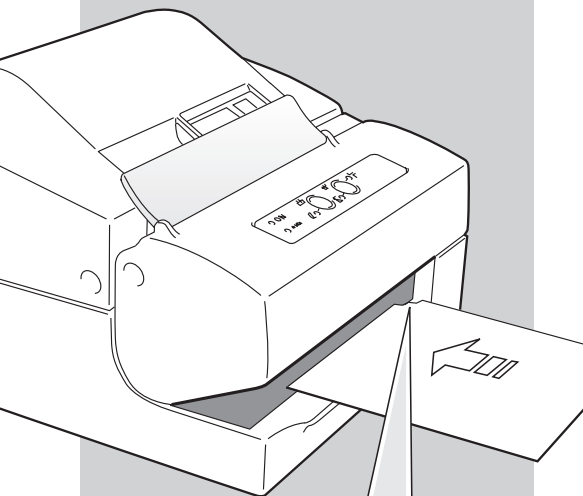

● ON

○ ERROR

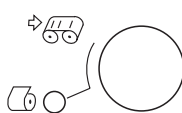

- Replacing the receipt roll
- Sostituzione del rotolo ricevute
- Remplacement du rouleau tickets
- Auswechseln der Quittungsrolle
- Sustitución del rollo de recibos

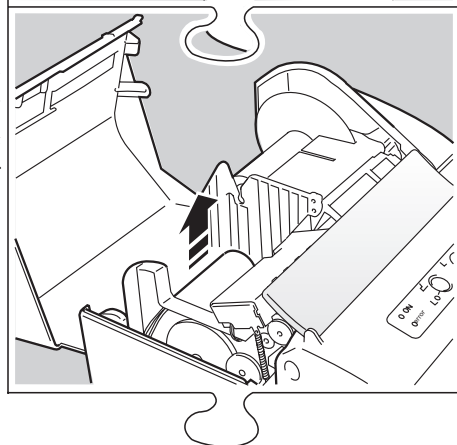
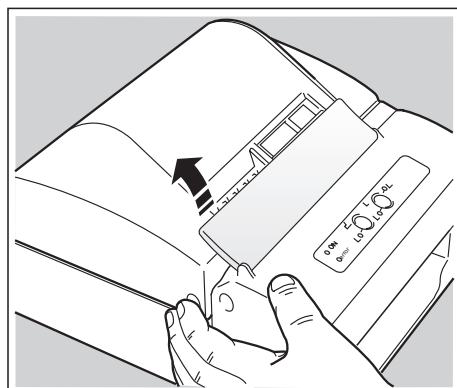
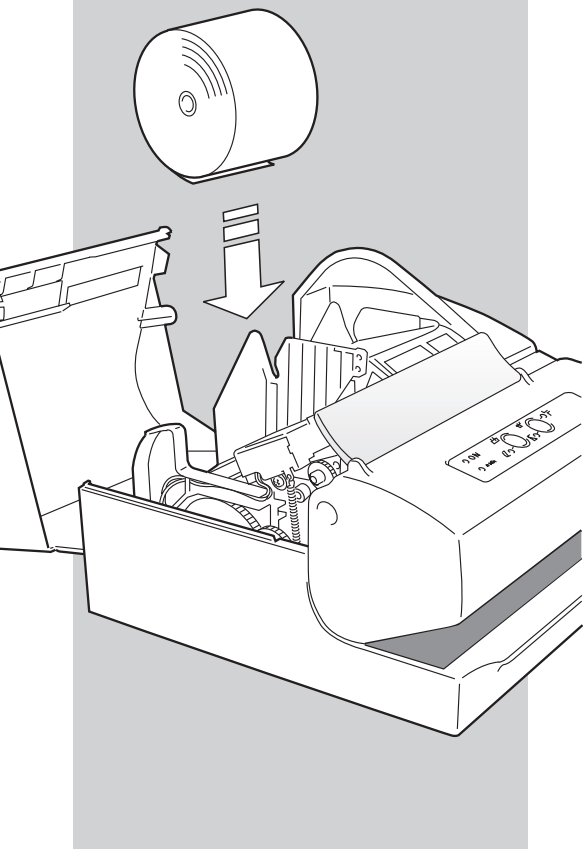

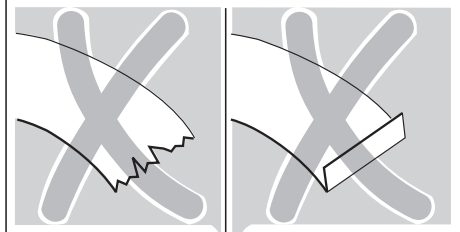
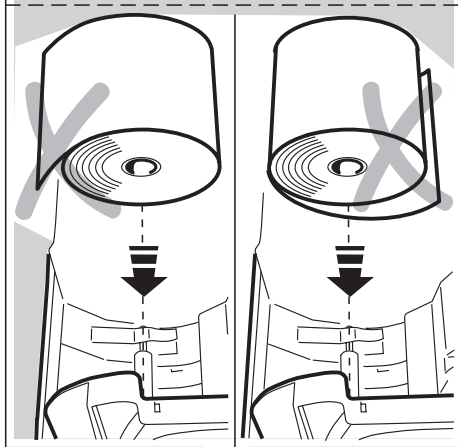
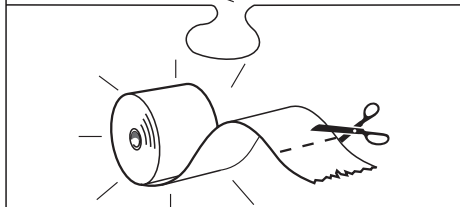
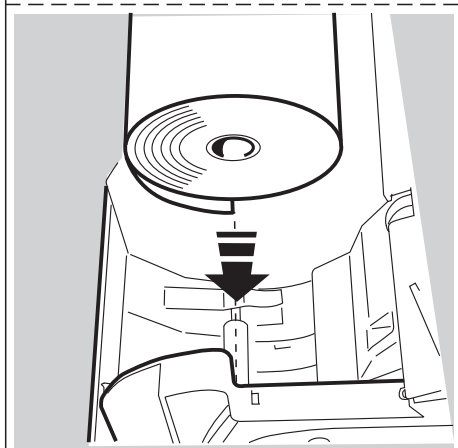
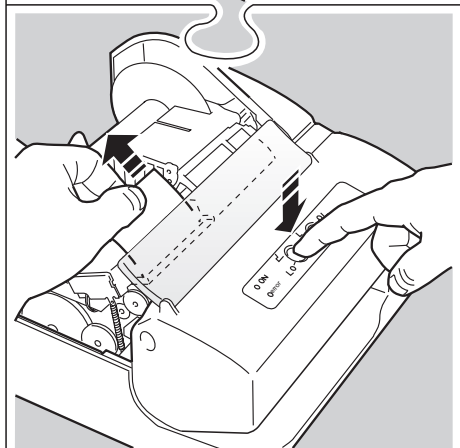
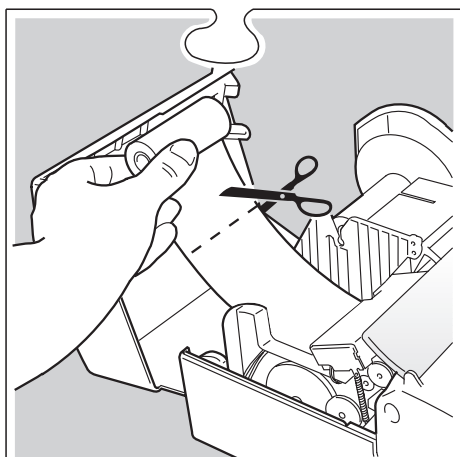

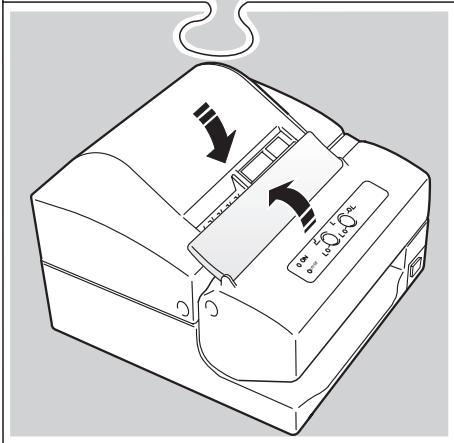
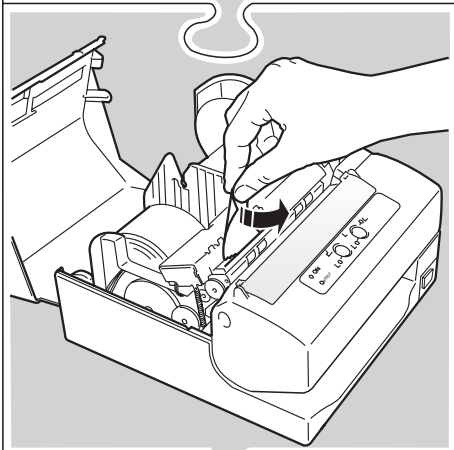
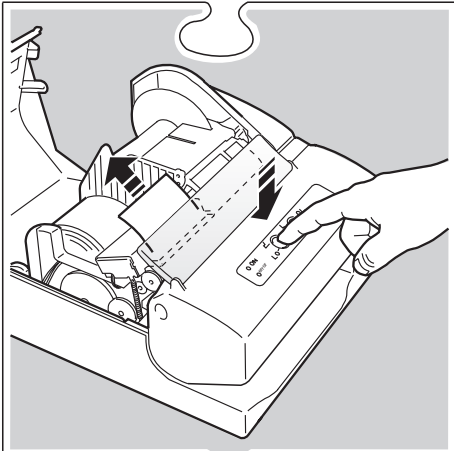

● ON

○ ERROR

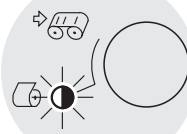
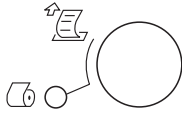

- Replacing the journal roll
- Sostituzione del rotolo giornale
- Remplacement du rouleau journal
- Auswechseln der Journalrolle
- Sustitución del rollo diario

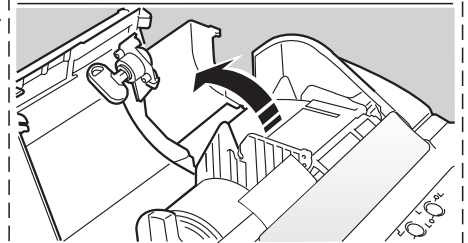
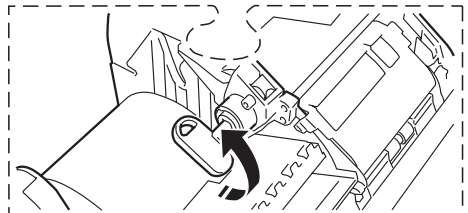
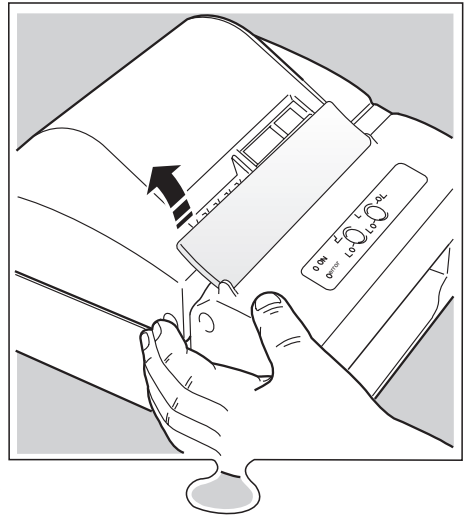
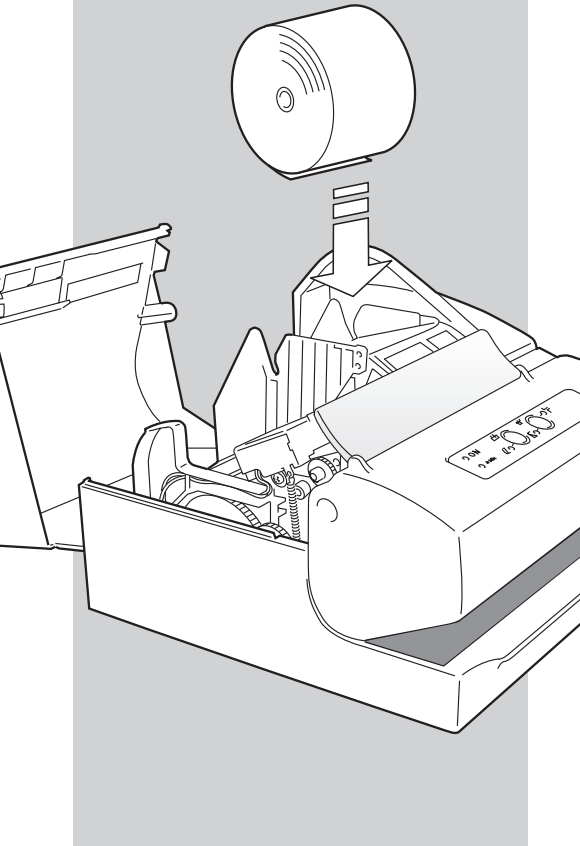

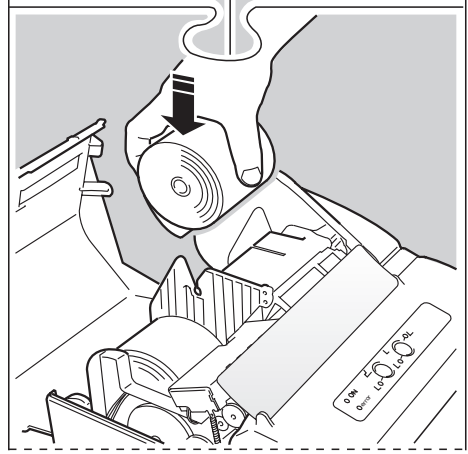
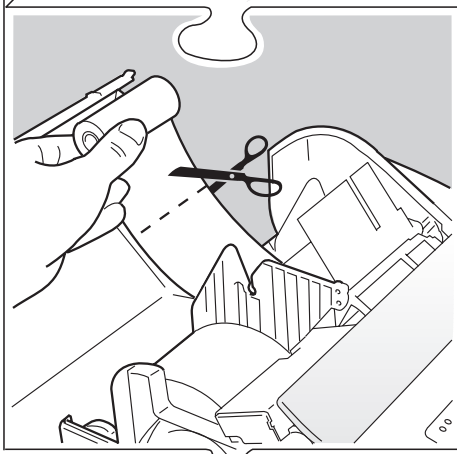
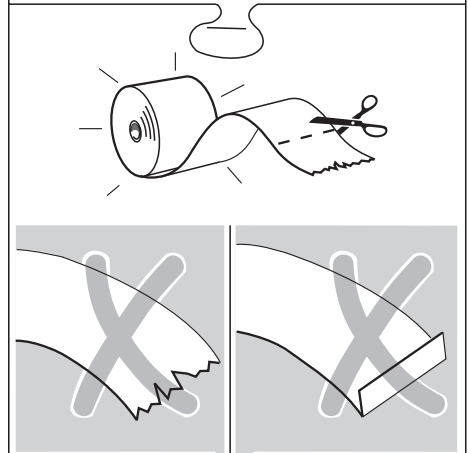
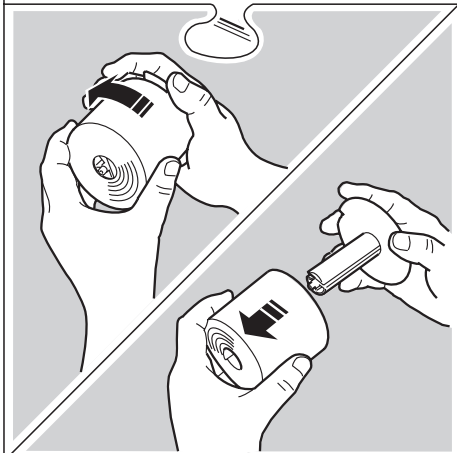
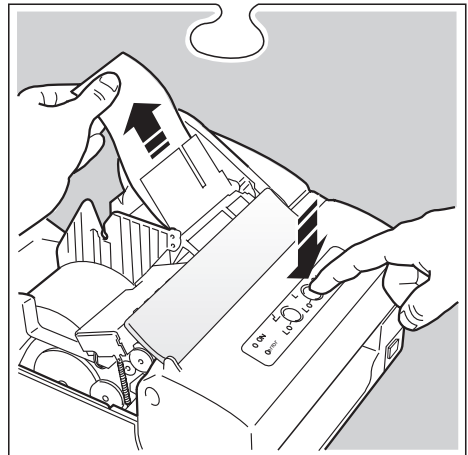
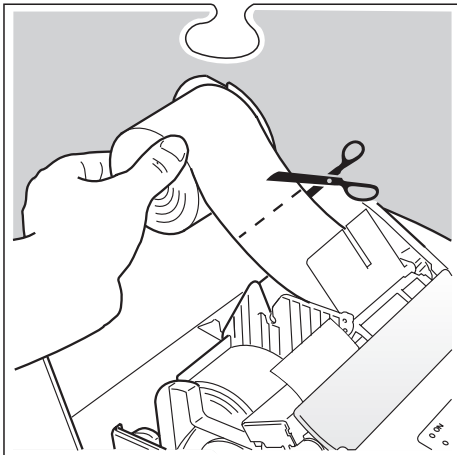

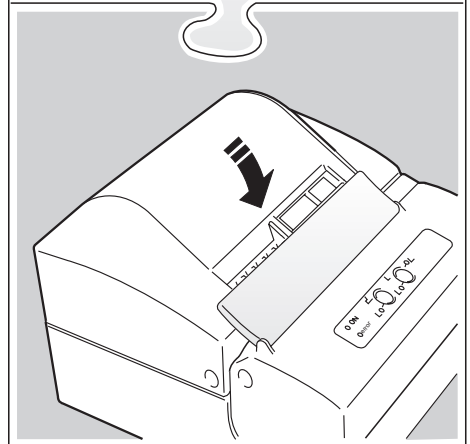
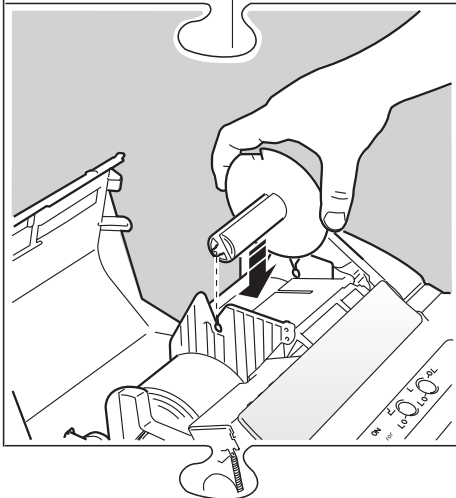
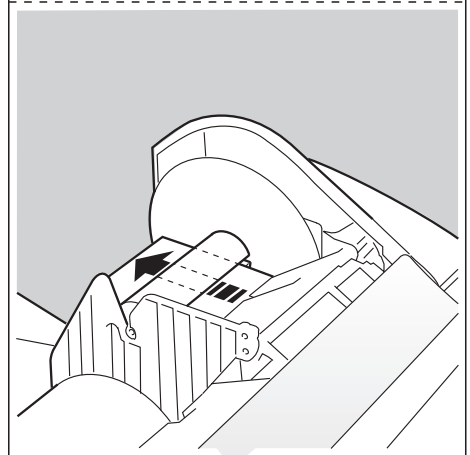
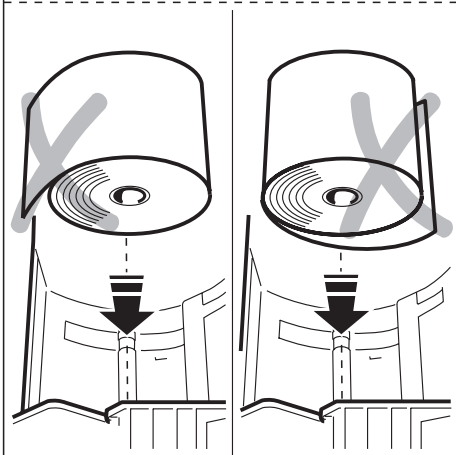
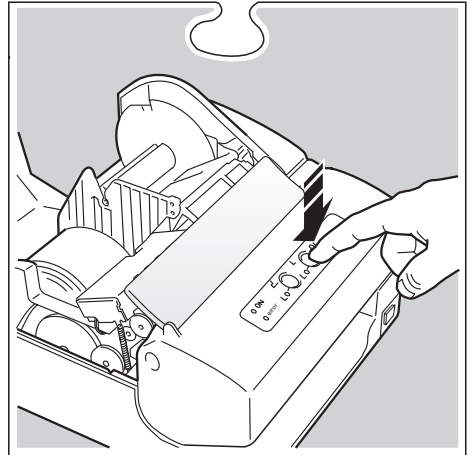
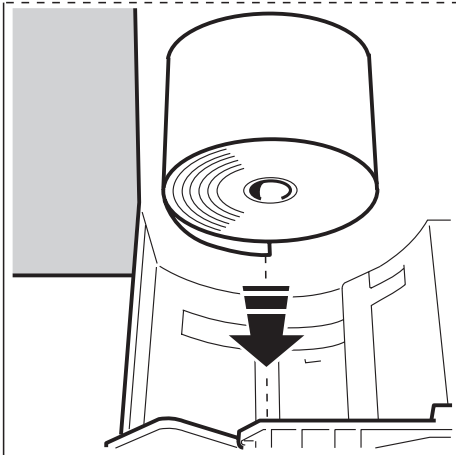

● ON

○ ERROR

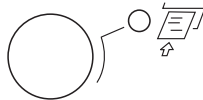
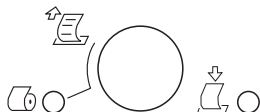

- Replacing the ribbon cartridge
- Sostituzione della cartuccia nastro
- Remplacement de la cartouche ruban
- Auswechseln des Farbbandes
- Sustitución del cartucho de cinta

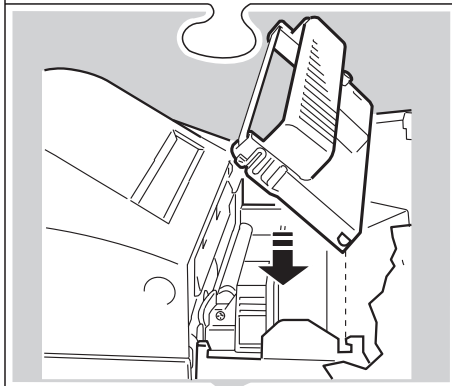
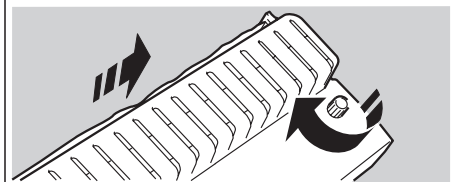
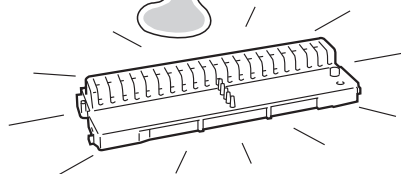
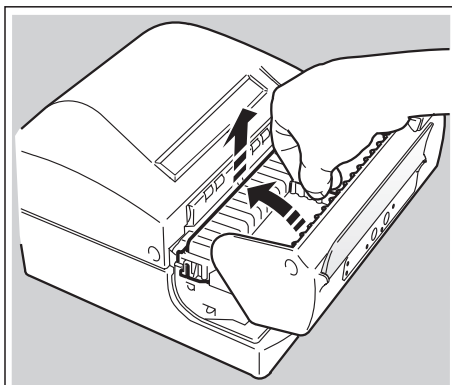
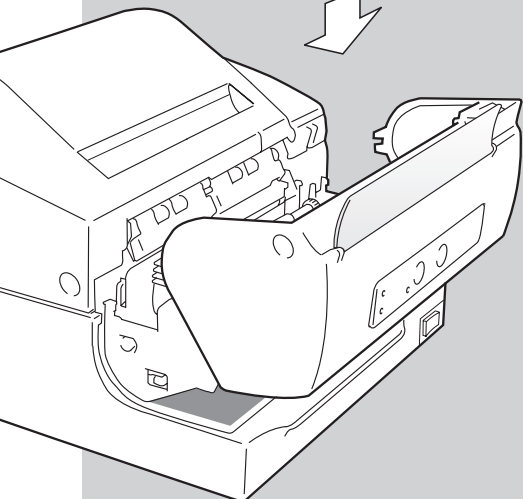
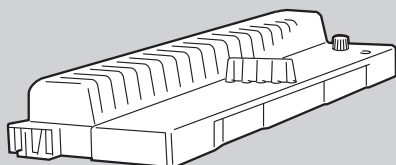

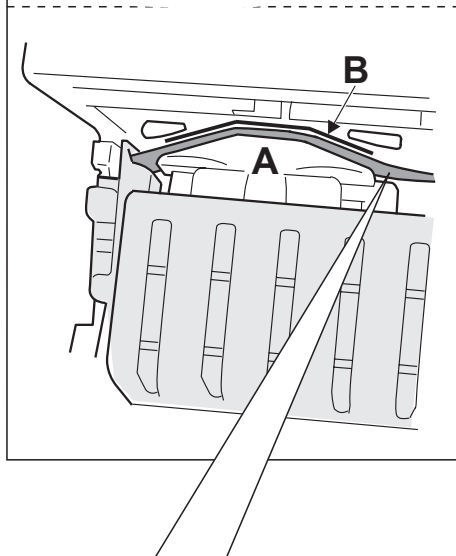
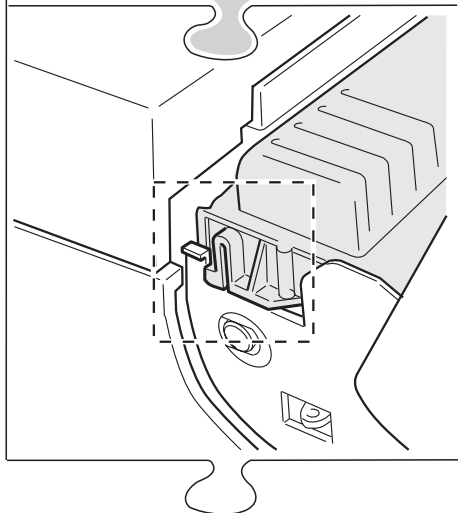
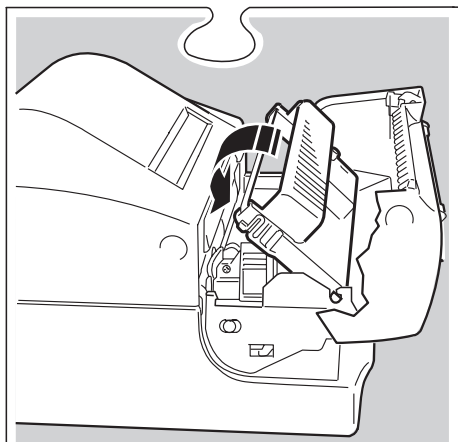

- GB** Tension the ribbon and ensure it is properly inserted between print head A and spatter guard B.
- I** Tendete il nastro e controllate che sia ben inserito tra la testina A e il lamierino antimacchia B.
- F** Tendez le ruban et contrôlez qu'il soit inséré correctement entre la tête d'impression A et la plaquette anti-tâche B.
- D** Spannen Sie das farbband nach und stellen Sie sicher, dass es richtig zwischen Druckkopf A und Antifleckenblech B eingesetzt ist.
- E** Tensar la cinta y controlar que esté bien insertada entre el cabezal A y la placa antimancha B.

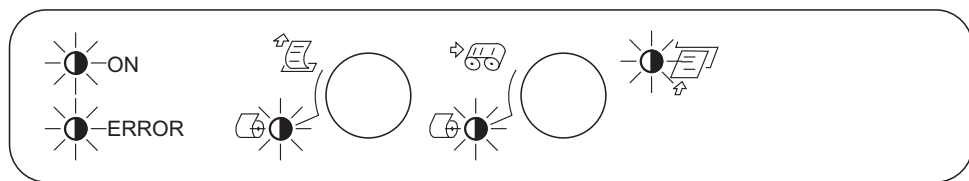

- **Improper closing of the printer covers**
- **Chiusura anomala dei coperchi della stampante**
- **Fermeture anormale des capots de l'imprimante**
- **Fehlerhaftes Schließen der Druckerabdeckungen**
- **Cierre incorrecto de las cubiertas de la impresora**

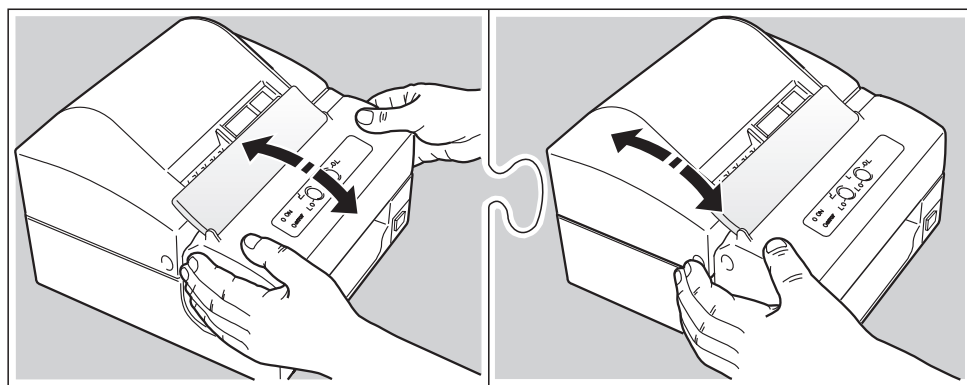

- GB** Check that the printer covers have been closed properly.
- I** Controllate che i coperchi della stampante siano ben chiusi.
- F** Vérifiez que les capots de l'imprimante sont bien fermés.
- D** Prüfen Sie, ob die Abdeckungen des Druckers richtig geschlossen sind.
- E** Asegurarse de que las cubiertas de la impresora estn bien cerradas.

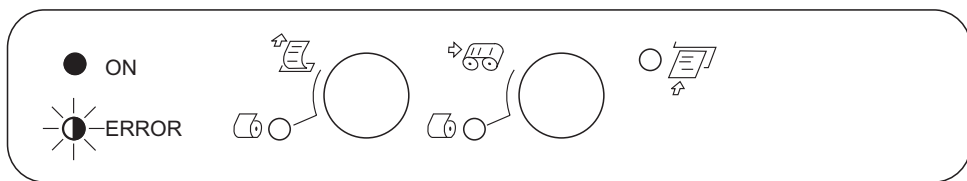

- **Cutter blocked**
- **Taglierina bloccata**
- **Massicot bloqué**
- **Versperre Schneidevorrichtung**
- **Cortapapel bloqueado**

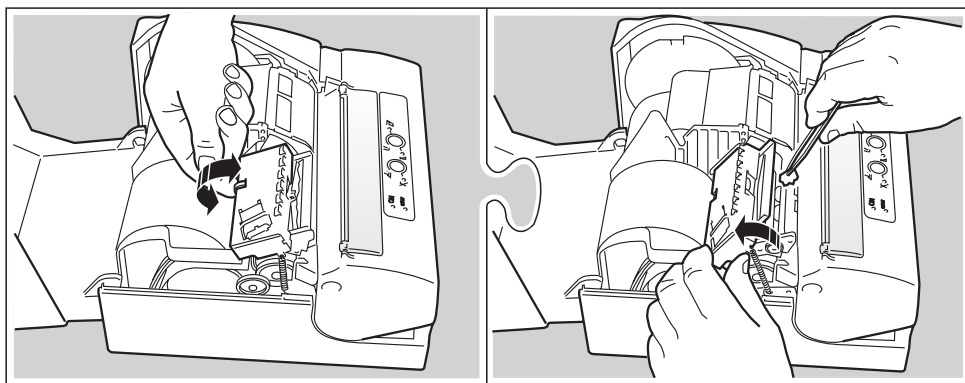

- GB**
1. Remove the jammed sheet and turn the wheel to fully retract the blades.
 2. Lift the cutter upwards and take out any paper shreds.

- I**
1. Rimuovete la carta inceppata e agitate sull'apposita rotella fino a far arretrare completamente le lame.
 2. Sollevare la taglierina verso l'alto e rimuovete gli eventuali ritagli di carta.

- F**
1. Dégagez le papier coincé puis tournez la molette pour déplacer les lames complètement vers l'arrière.
 2. Soulevez le massicot et ôtez les chutes de papier éventuelles.

- D**
1. Entfernen Sie das gestaute Papier und drehen Sie das entsprechende Rädchen, bis die Klingen vollständig zurückgezogen sind.
 2. Heben Sie die Schneidevorrichtung an und entfernen Sie eventuelle Papierreste.

- E**
1. Extraer el papel atascado y girar la rueda correspondiente para hacer retroceder el completamente las cuchillas.
 2. Alzar el cortapapel y extraer los eventuales recortes de papel.

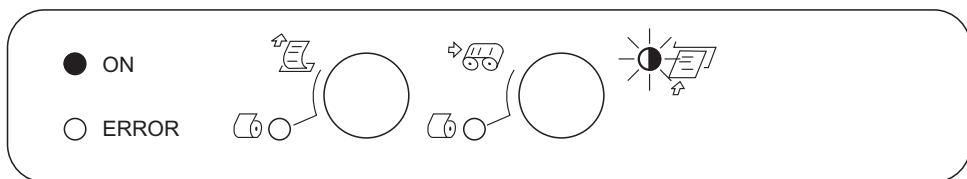

- **Front loading: document rejected**
- **Caricamento frontale: documento rifiutato**
- **Chargement frontal : document refusé**
- **Laden von der Vorderseite: Dokument abgewiesen**
- **Carga frontal: documento rechazado**

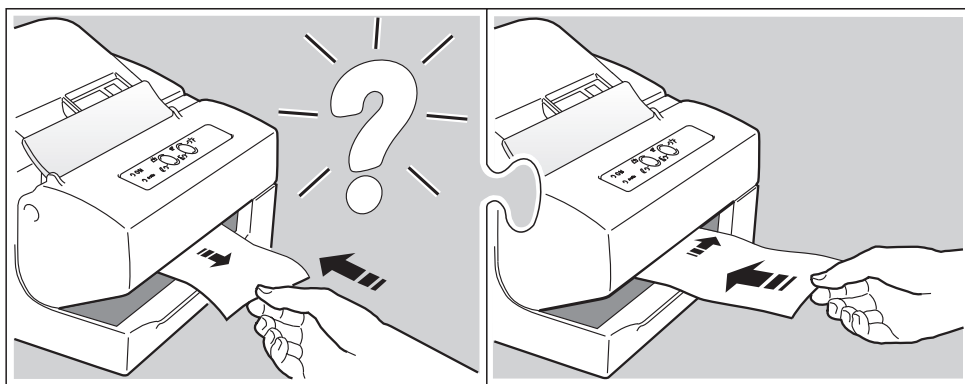

GB If a document inserted from the front is fed and rejected, insert it again more carefully.

I Se il documento inserito frontalmente viene alimentato e rifiutato, ripetete l'inserimento con maggior cura.

F Si le document inséré frontalement est alimenté puis éjecté, réinsérez-le avec soin.

D Wenn das von der Vorderseite geladene Papier eingezogen und anschließend abgewiesen wird, wiederholen Sie das Einlegen mit größerer Sorgfalt.

E Si el documento introducido frontalmente es alimentado y rechazado, repetir la introducción con más cuidado.

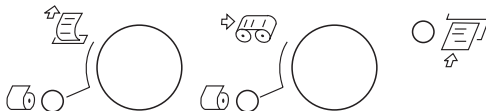
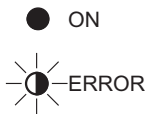

- Paper jam
- Inceppamento carta
- Bourrage papier
- Papierstau
- Atasco del papel

GB Grip the jammed roll, release the paper guide and pull upwards to remove completely the roll. If the paper extends in front in the print zone, **first** tear off and remove carefully this part of the jammed paper.

I Afferrate il rotolo inceppato, sganciate il guidacarta e rimuovete completamente il rotolo tirandolo verso l'alto. Se la carta fuoriesce davanti nella zona di stampa, occorre **prima** strappare e rimuovere con cura questa parte di carta inceppata.

F Saisissez le rouleau de papier coincé, débloquez le guide-papier et ôtez complètement le rouleau en le tirant vers le haut. Si le papier sort devant, dans la zone d'impression, vous devez **tout d'abord** déchirer et enlever soigneusement le morceau de papier coincé.

D Greifen Sie die gestaute Rolle, haken Sie die Papierführung aus und nehmen Sie die Rolle dann ganz heraus, indem Sie sie nach oben ziehen. Wenn das Papier vorne im Druckbereich austritt, muß dieser gestaute Papierteil **zuerst** abgerissen und sorgfältig entfernt werden.

E Sujetar el rolo atascado, desenganchar la guía del papel y extraer completamente el rolo tirando hacia arriba. Si el papel sobresale delante en la zona de impresión, es preciso **antes** rasgar y extraer con atención esta parte de papel atascado.

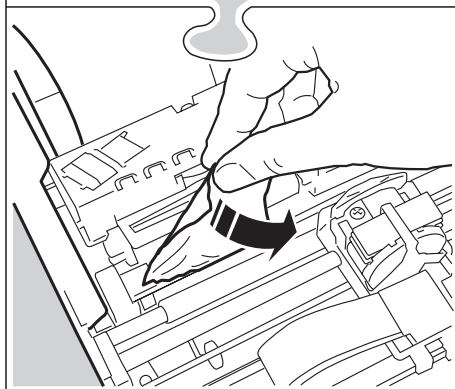
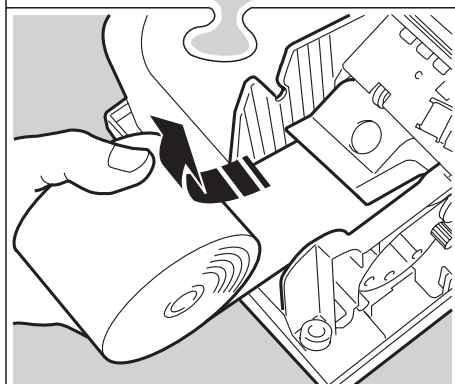
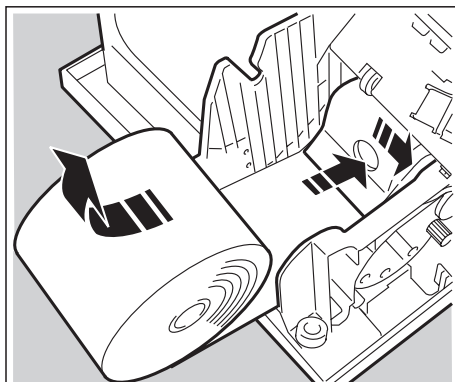

- Console LED indications
- Segnalazioni luminose di console
- Signalisations lumineuses sur le panneau de commande
- Leuchtanzeigen auf dem Bedienfeld blinken
- Señalizaciones luminosas en la consola

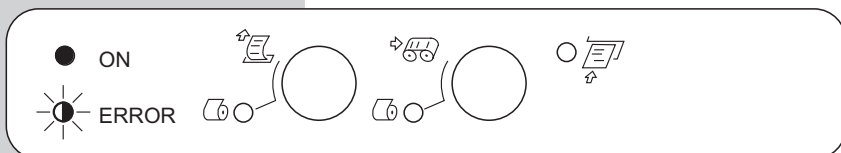
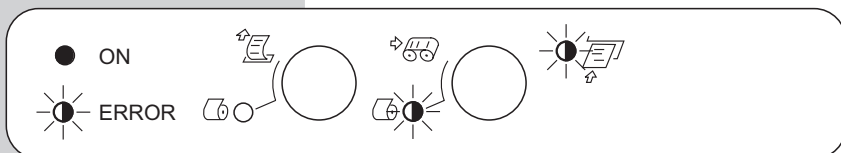
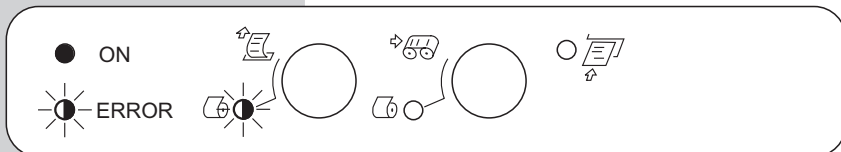
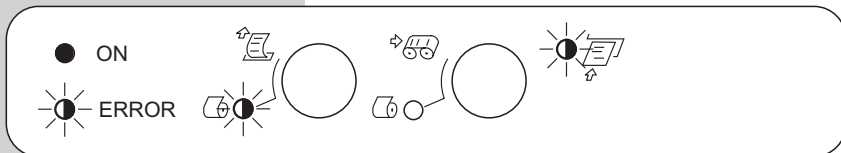
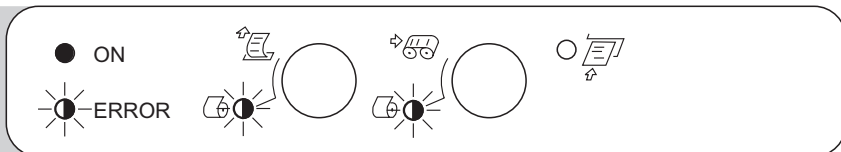

- GB** Call Customer Service
- I** Chiamate l'Assistenza tecnica
- F** Appelez le service d'assistance technique
- D** Kundendienst rufen
- E** Lamar el Servicio de asistencia técnica

Part Number 475363 H

Printed in Italy

olivetti